

S2

RACING SUSPENSION MODULE SW-05217

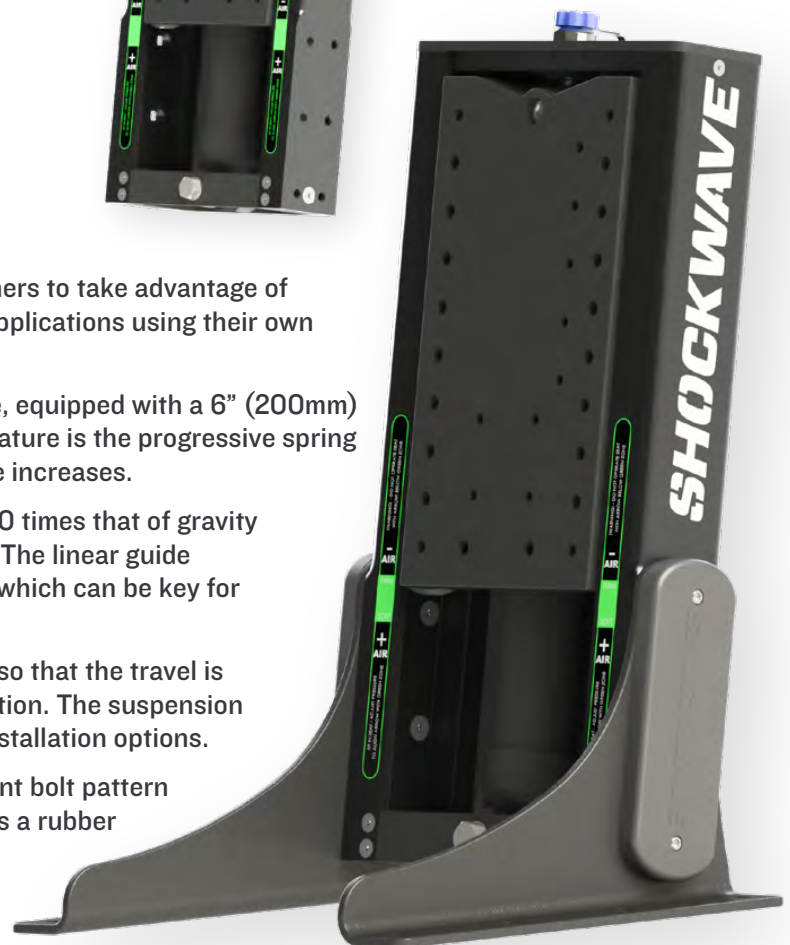

TRAVEL
6 IN



S2 module shown with deck mount

The S2 Racing Suspension Module allows race boat designers to take advantage of Shockwave premium suspension performance in custom applications using their own rear-mounted seats.

This is a high-performance suspension unit for intense use, equipped with a 6" (200mm) travel FOX Float H2O shock made by Fox Defense. A key feature is the progressive spring rate of the shock which causes it to stiffen up as the stroke increases.

The suspension is designed to handle accelerations up to 10 times that of gravity with an occupant up to the 95th percentile male in weight. The linear guide suspension design won't bind during off-axis wave impact which can be key for off-shore races.

The air-sprung shock allows users to tune the suspension so that the travel is limited to what will work for each specific boat and installation. The suspension module can be deck or bulkhead mounted to allow many installation options.

The suspension module carriage offers a number of different bolt pattern options for seat mounting. The suspension module includes a rubber bump stop at the base, protecting the user in case of the unlikely event of decompression so that the suspension will not bottom out.

Shockwave has been making marine suspension products for over 20 years and our constant desire to improve and refine our products is evident in the performance of the S2 Racing Suspension Module.

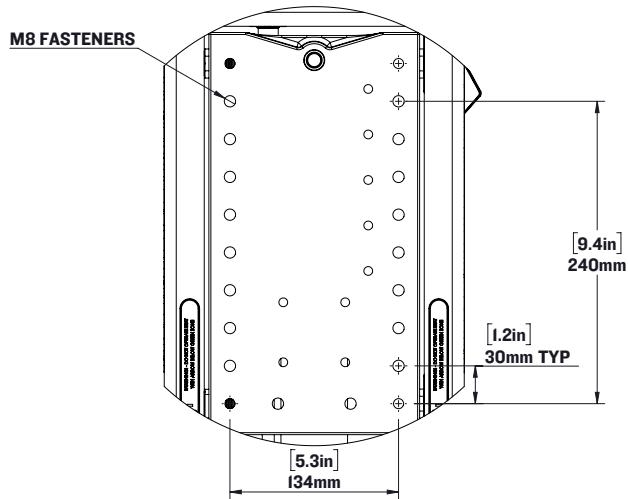
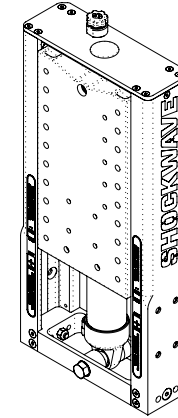
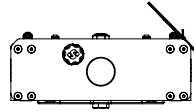
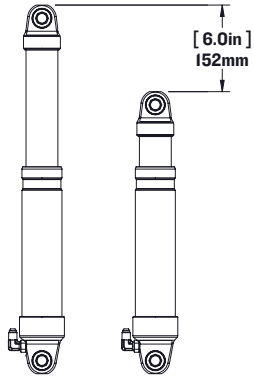

DETAIL A
SCALE 1 : 6

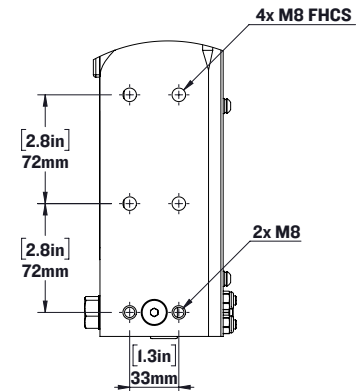
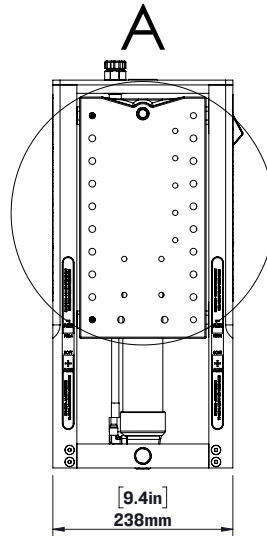

DETAIL B
SCALE 1 : 5

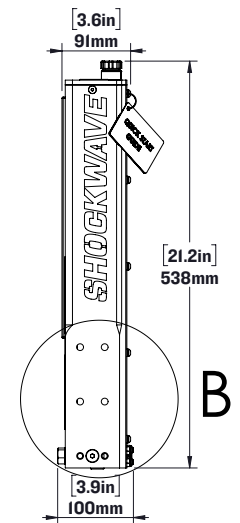

NOTES:

1. CONTACT SHOCKWAVE FOR INSTALLATION ASSISTANCE
2. SUGGESTED MODULE INSTALLATION ANGLE IS 10 DEGREES FROM VERTICAL

SHOCKWAVE

FOR MORE INFORMATION
CALL US AT 1-778-426-8545
OR VISIT US ONLINE AT
WWW.SHOCKWAVESEATS.COM

PROPRIETARY AND CONFIDENTIAL

NOTICE: THIS DRAWING MAY REVEAL DESIGNS OR INFORMATION PROPRIETARY TO PROFESSIONAL COMPONENTS LTD. BY ACCEPTANCE OF REPRODUCTIONS, RECIPIENTS AGREE TO PROTECT PROFESSIONAL COMPONENTS LTD. RIGHTS AND ARE WARNED AGAINST USE OF THE DOCUMENT FOR ANY PURPOSE OTHER THAN THAT FOR WHICH IT WAS ISSUED.

SW-05217
S2A Metric Module

WEIGHT: [21.6 lbs] 9.8 kg

SCALE: 1:10

SHEET 1 OF 1

REV: 04

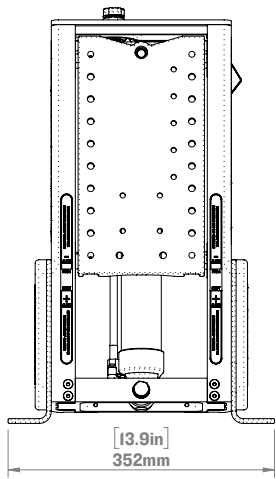

WITH SW-03620 DECK MOUNT

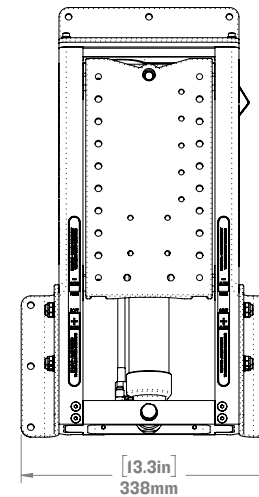
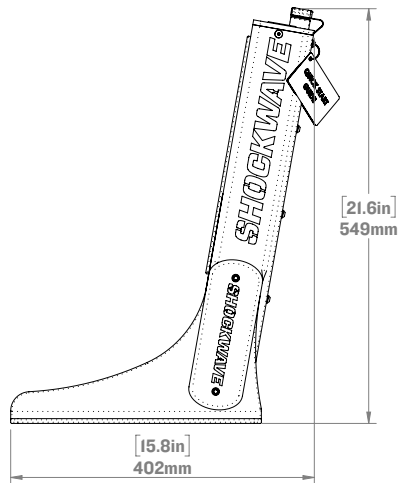

WITH SW-04656 0 DEGREE BULKHEAD MOUNT

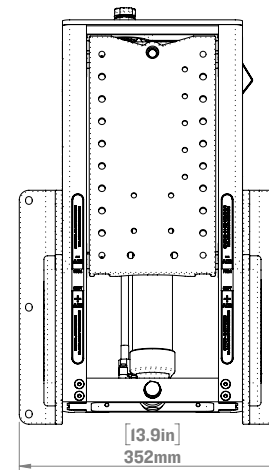
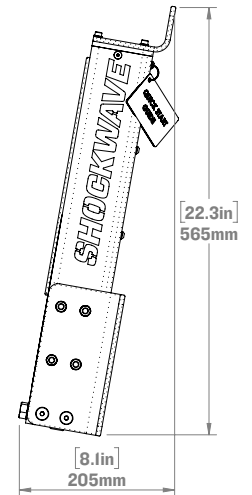

WITH SW-04871 10 DEGREE BULKHEAD MOUNT

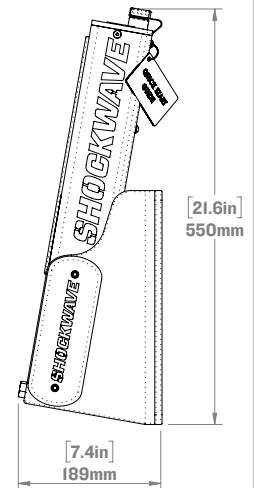

NOTES:

1. CONTACT SHOCKWAVE FOR INSTALLATION ASSISTANCE
2. SUGGESTED MODULE INSTALLATION ANGLE IS 10 DEGREES FROM VERTICAL

SHOCKWAVE

FOR MORE INFORMATION
CALL US AT 1-778-426-8545
OR VISIT US ONLINE AT
WWW.SHOCKWAVESEATS.COM

PROPRIETARY AND CONFIDENTIAL
NOTICE: THIS DRAWING MAY REVEAL DESIGNS OR INFORMATION
PROPRIETARY TO PROFESSIONAL COMPONENTS LTD. BY
ACCEPTANCE OF REPRODUCTIONS, RECIPIENTS AGREE
TO PROTECT PROFESSIONAL COMPONENTS LTD. RIGHTS
AND ARE WARNED AGAINST USE OF THE DOCUMENT FOR
ANY PURPOSE OTHER THAN THAT FOR WHICH IT WAS ISSUED.

SW-05217
S2A Metric Module

WEIGHT: [21.6 lbs] 9.8 kg SCALE:1:10 SHEET 2 OF 2 REV: 06